

- Электронное строение

S Z Vars

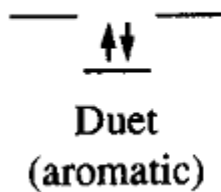

S Z Vars

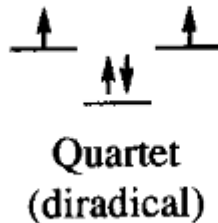

S Z Var

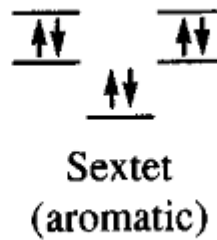

S Z Var

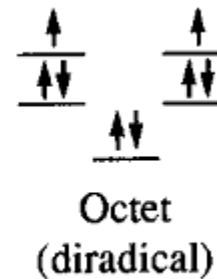

S Z Varsadze's lectures

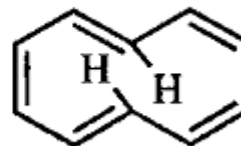
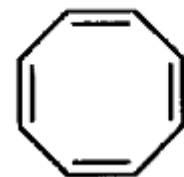
S  
lecturesS  
lectures

S Z Varsadze's lectures

- Критерии ароматичности

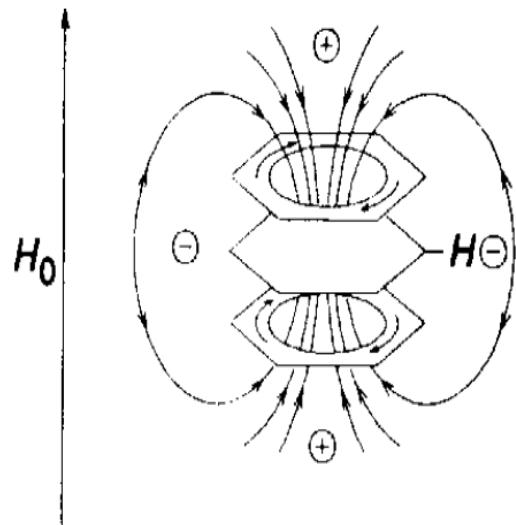

1.4.1. Магнитные критерии: хим. сдвиги  $^1\text{H}$  в спектрах ЯМР

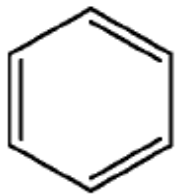

5

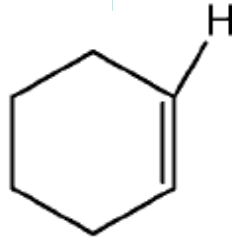

6

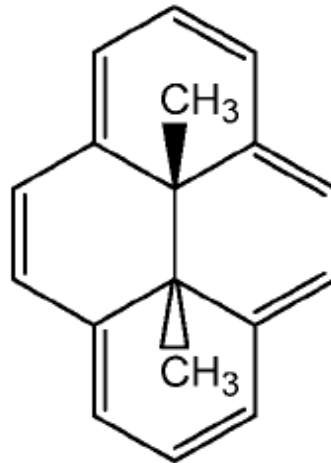

7

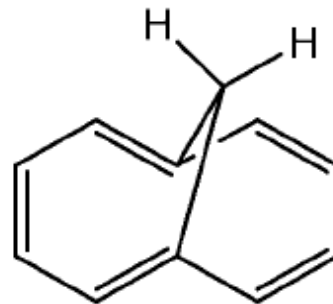

8

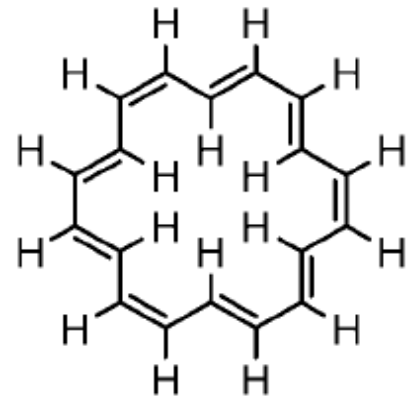

9

NMR  $\delta^1\text{H}$  [ppm] 7.3

5.6

Ring 8.14-8.67  
 $\text{CH}_3$  -4.25

Ring 6.95-7.27  
 $\text{CH}_2$  -0.51

Outer 9.0  
 Inner -3.0

- 2 электрона

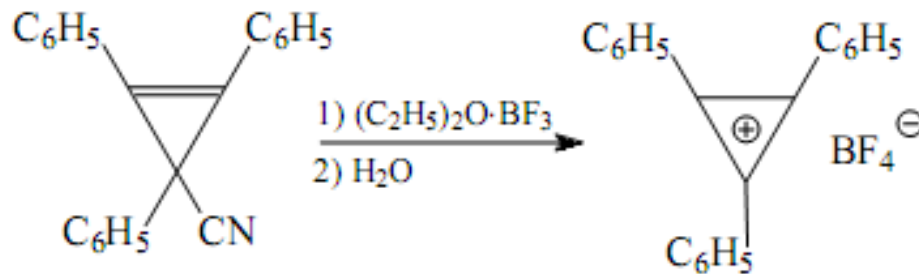
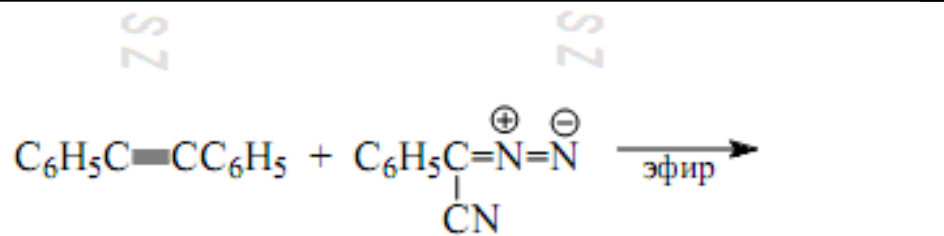

SZ Varsadze's lectures

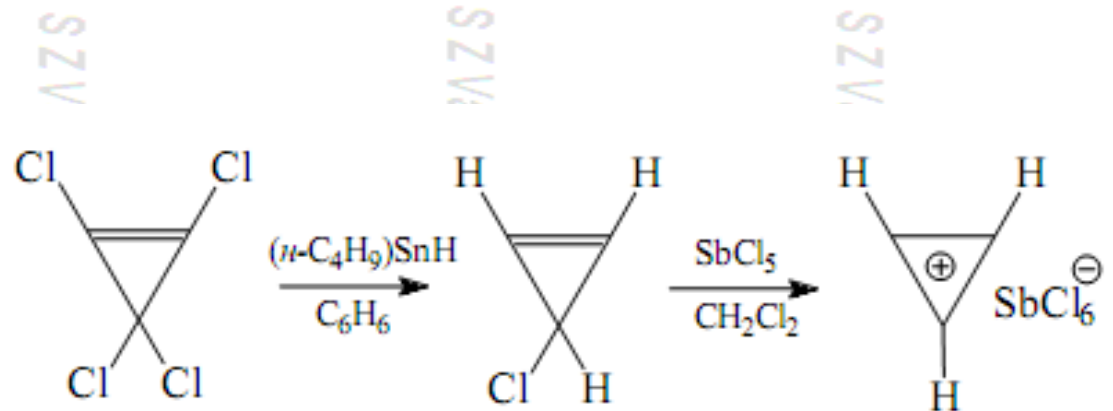

- 2 электрона

S Z Varsadze's /

S Z Varsadze's /

S Z Varsadze's

S Z Varsadze's

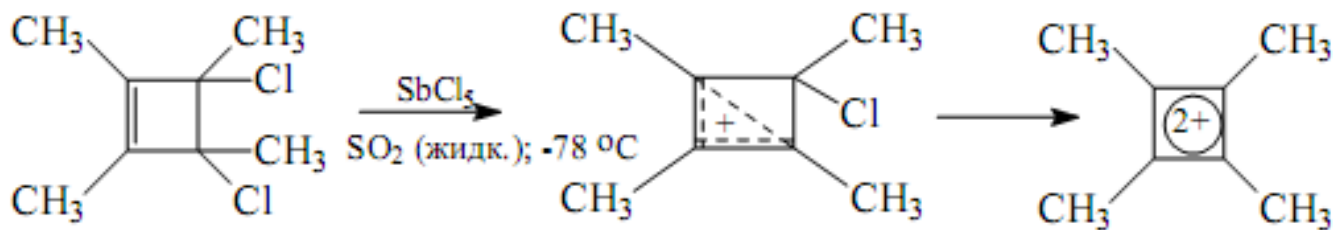
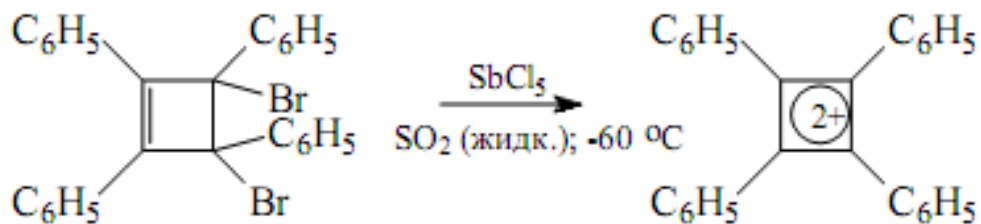

lectures

lectures

lectures

lectures

Устойчив при низких темп.

- 4 электрона

S Z Varsadze's lectures

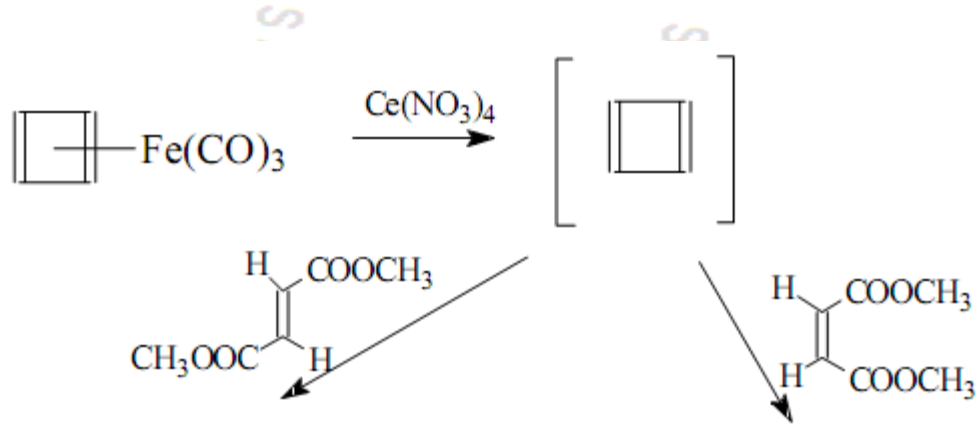

S Z Varsadze's lectures

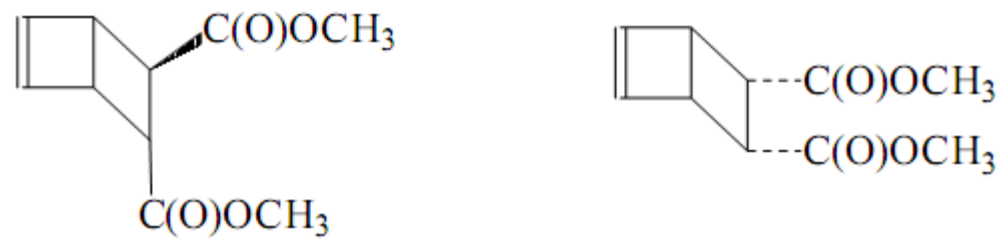

S Z Varsadze's lectures

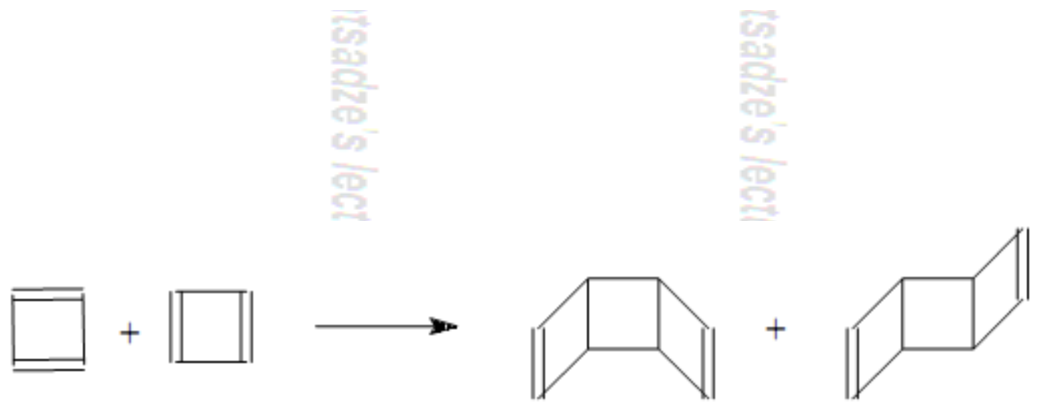

S Z Varsadze's lectures

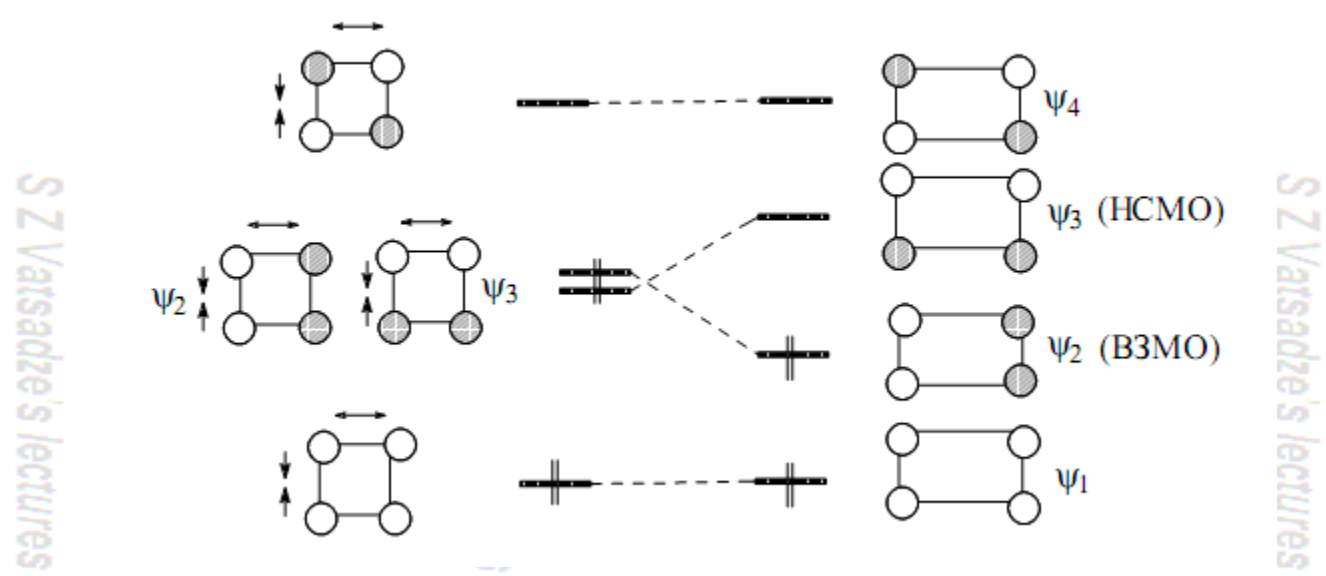
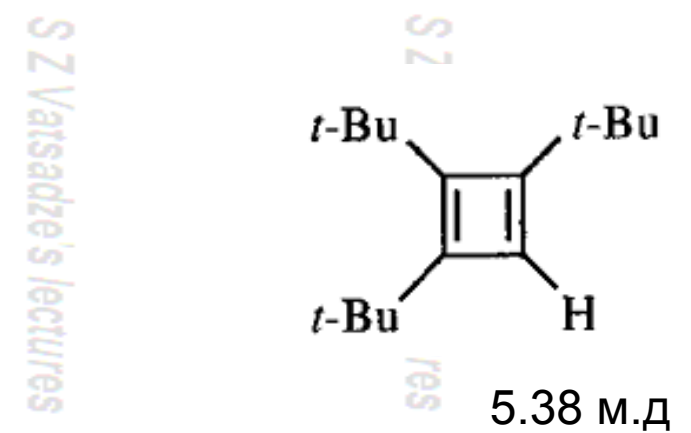
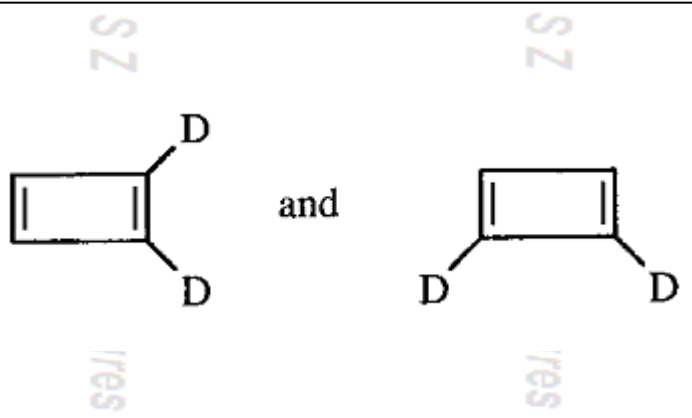

Расчеты – 1.57 и 1.34 ангстр.

- 4 электрона

S Z Vatsadze's lectures

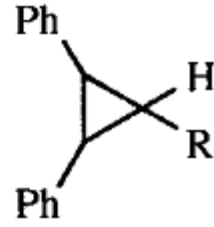

S Z Vatsad

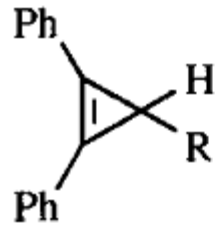

S Z Vatsad

S Z Vatsadze's lectures

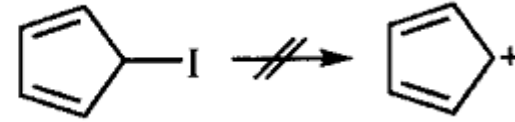

S Z Vatsadze's lectures



S Z Vatsadze's lectures

S Z Vatsadze's lectures

S Z Vatsadze's lectures



- 6 электронов

S Z Varsadze's lectures

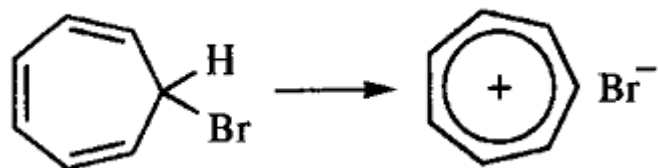

S Z Varsadze's le

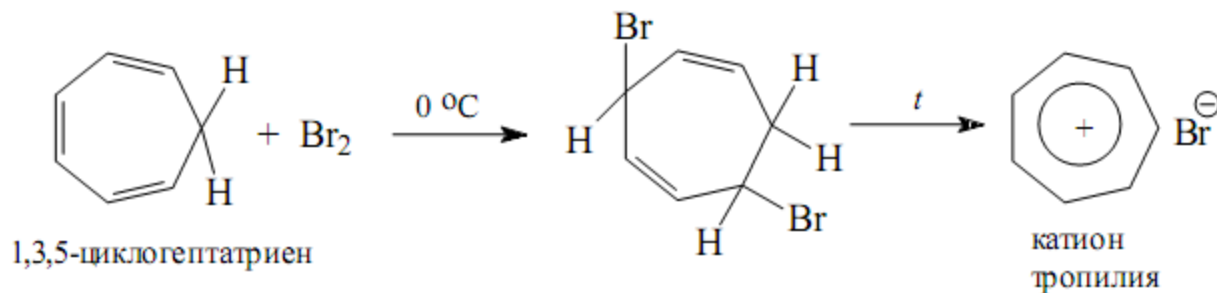

S Z Varsadze's lectures

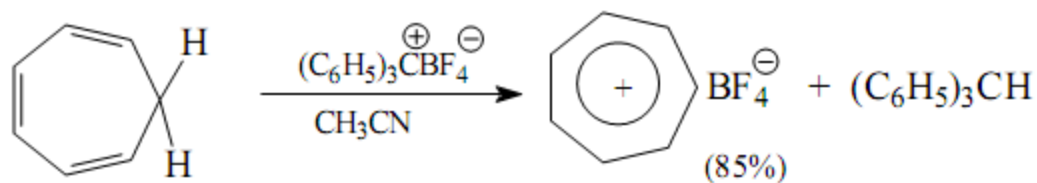
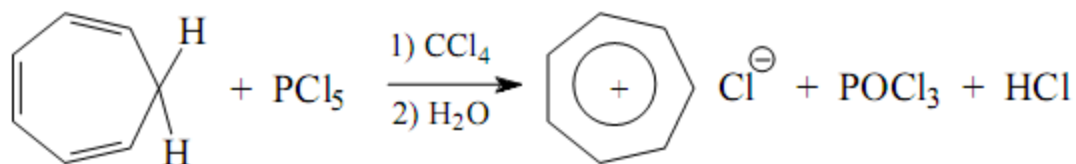

- Электронное строение: линейный и циклический полиен

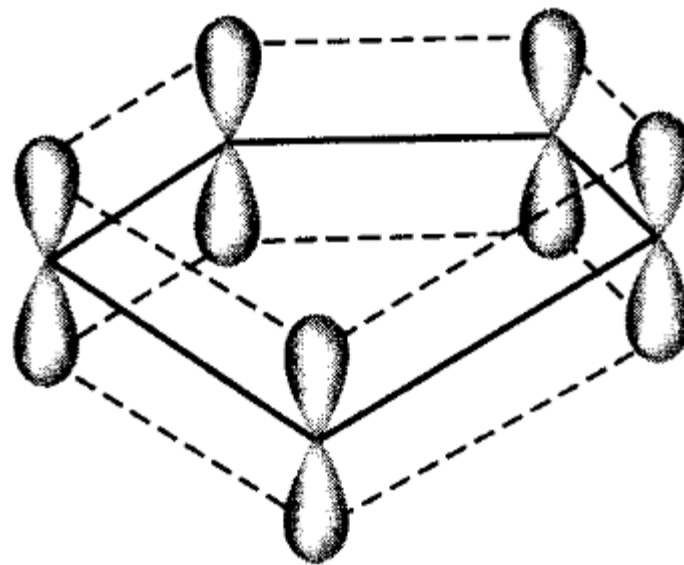

S Z Varsadze's lectures

S Z

S

S Z Varsadze's lectures

S Z Varsadze

Varsadze

Varsadze

S Z Varsadze

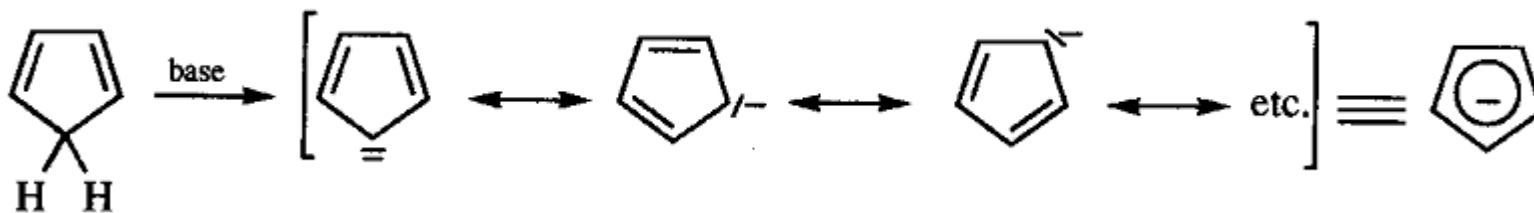

- 6 электронов

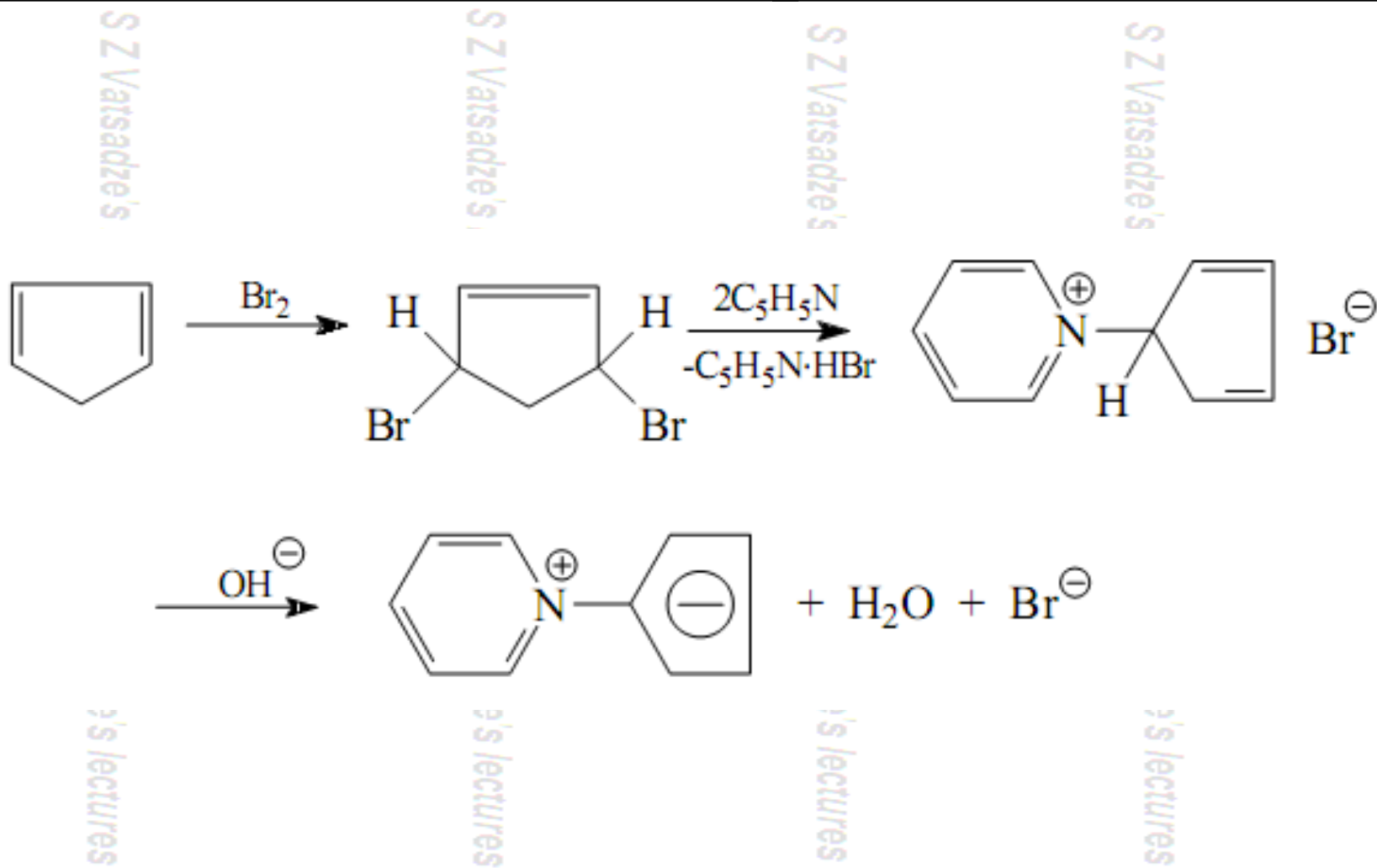

- 6 электронов ?

S Z Varsadze's lectures

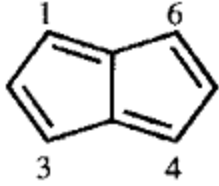

S Z Vars:

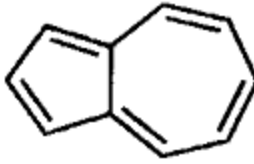

S Z Vars

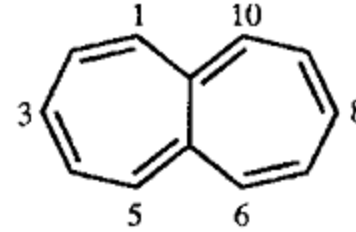

S Z Vars

S Z Varsadze's lectures

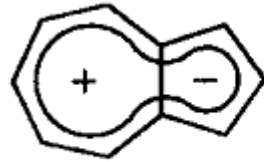

S Z V

res

S Z V



51

es

S Z Varsadze's lectures

- Электронное строение: семейство сопряженных полиенов

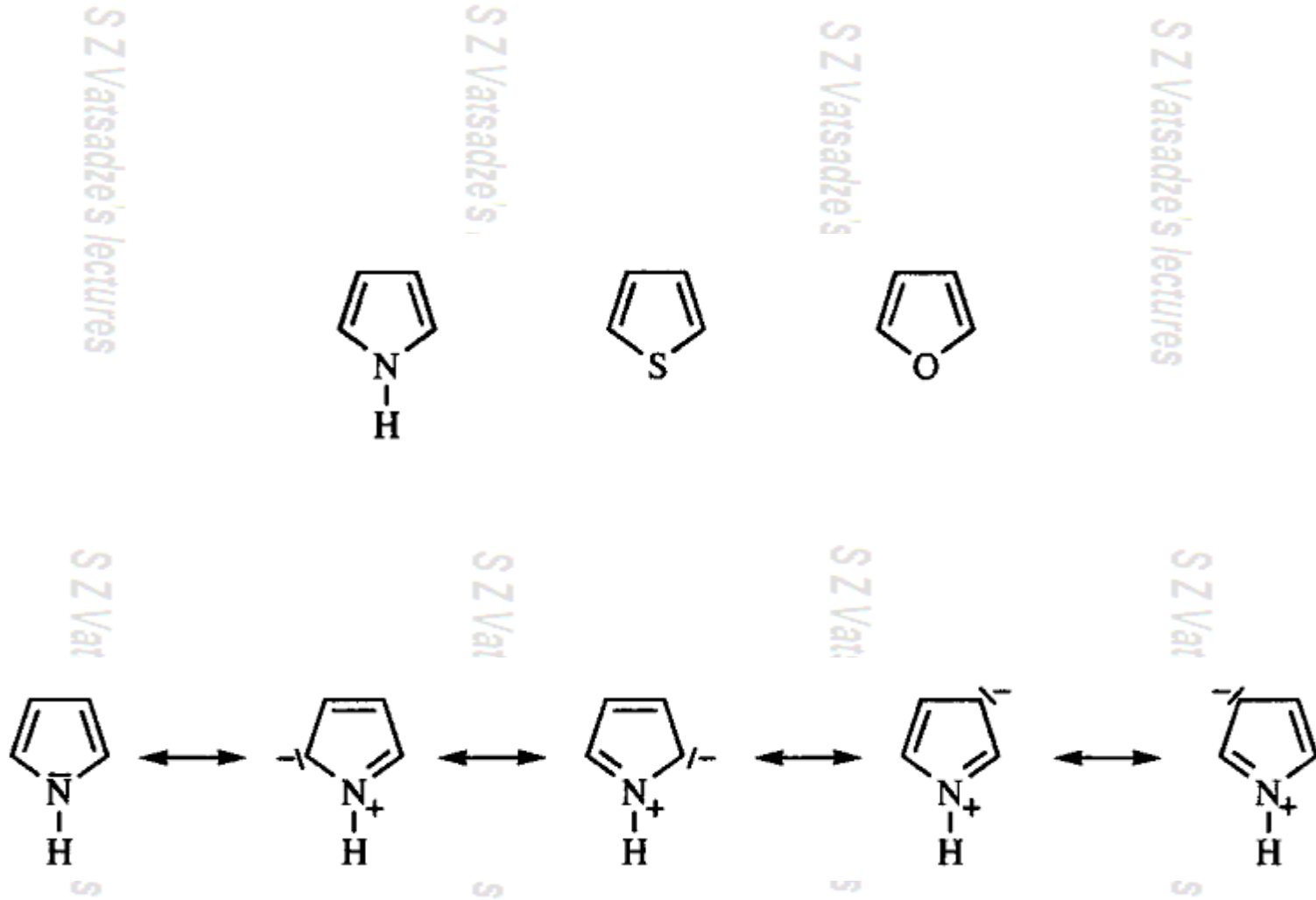

- 6 электронов

SZ Varsadze's lectures

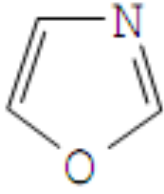

SZ Varsadze's lectures

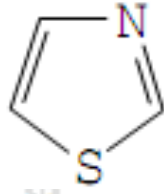

SZ Varsadze's lectures

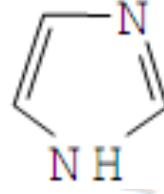

SZ Varsadze's lectures

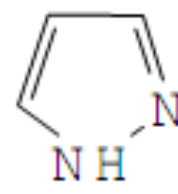

SZ Varsadze's lectures

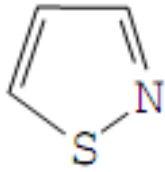

SZ Varsadze's lectures

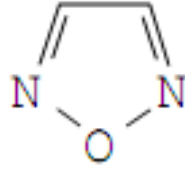

SZ Varsadze's lectures

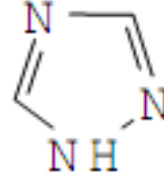

SZ Varsadze's lectures

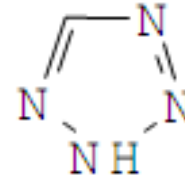

• Ароматичность

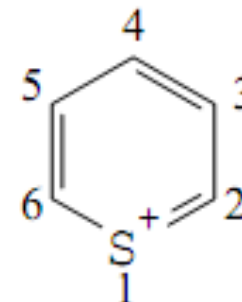
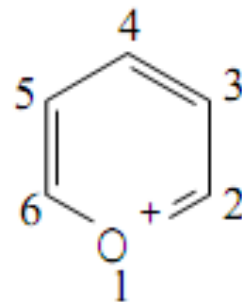
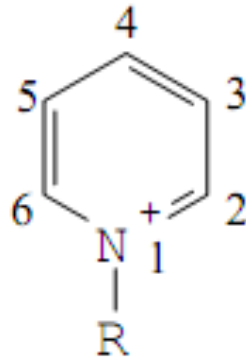
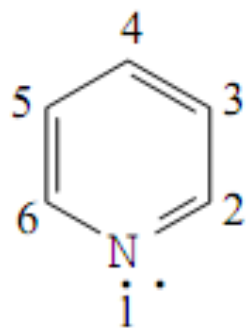

SZ Varsadze's lectures

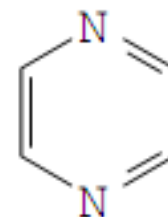
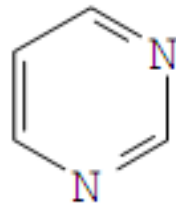
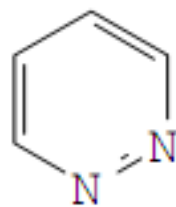

175a1

175a1

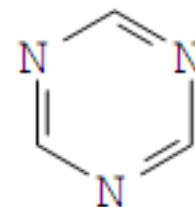
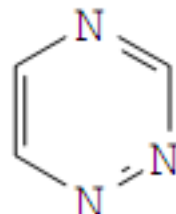
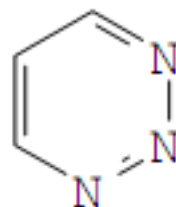

SZ Varsadze's lectures

Цикло-N<sub>6</sub> ?????

- 6 электронов – 10 электронов

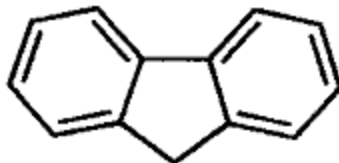
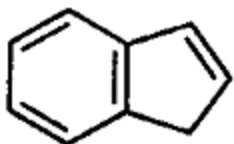

Fluorene

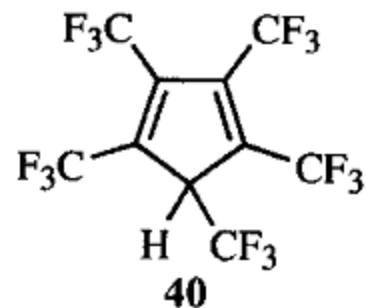

Сильнее азотной к-ты



- 8 электронов

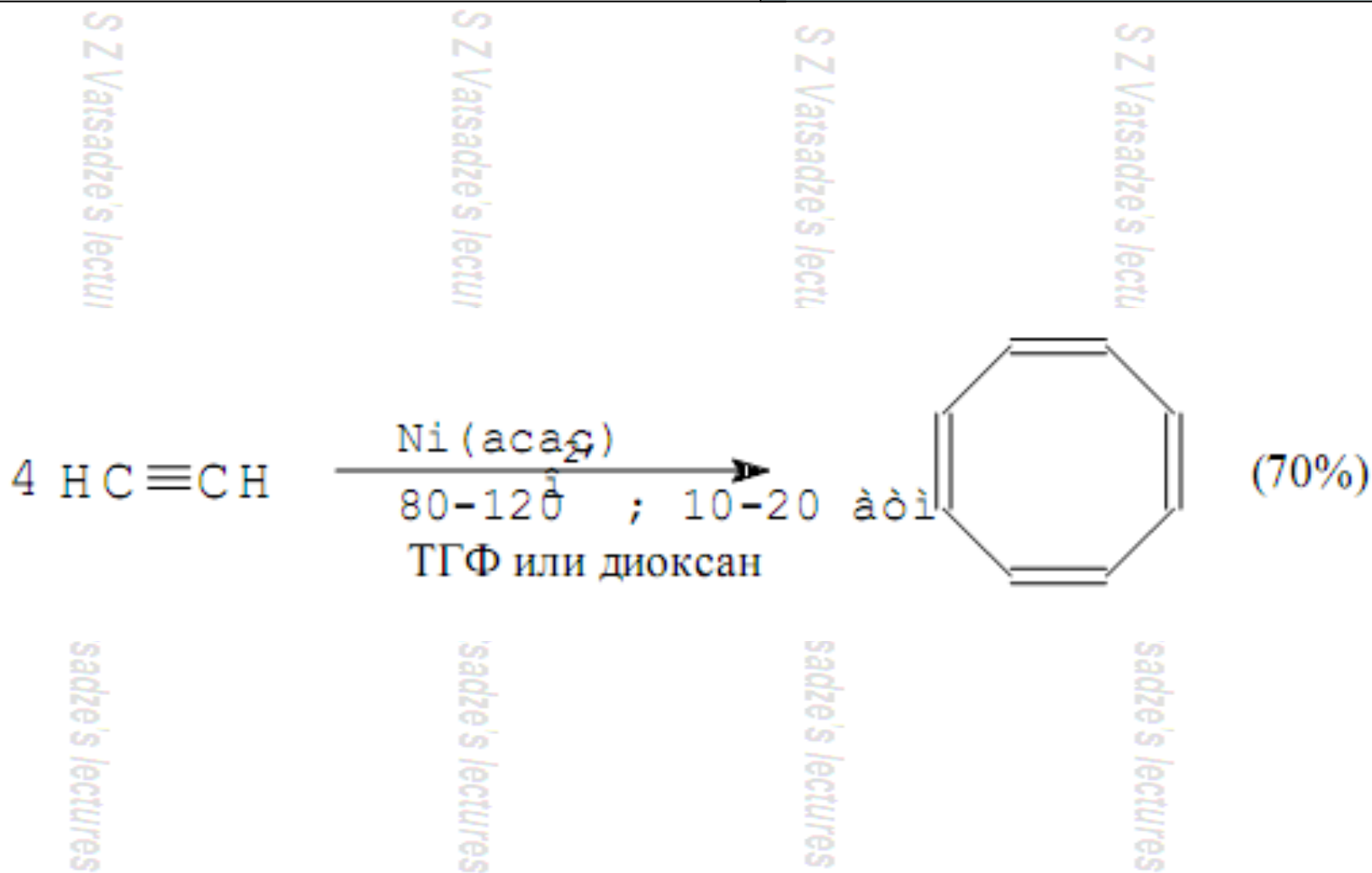

- 10 электронов

S Z Vatsadze's lectures

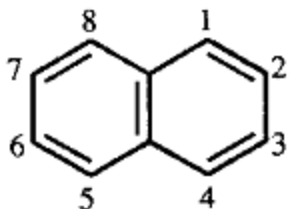

S Z Vatsadze's lectures

S Z Vatsadze's lectures



Z Vatsadze's lectures

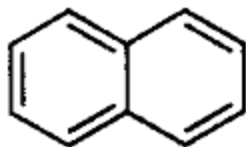

S Z Vatsadze's lectures



Z Vatsadze's lectures

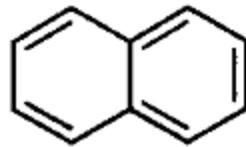

S Z Vatsadze's lectures

Z Vatsadze's lectures

- 10 электронов

S Z Varsadze's lectures

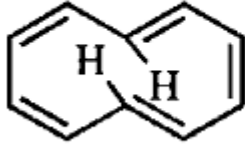

S Z Va

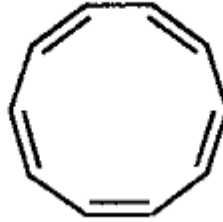

S Z V

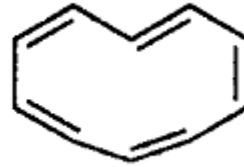

S Z Varsadze's lectures

S Z Varsadze's lectures

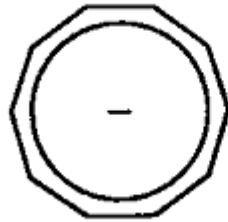

S Z Varsadze's lectures

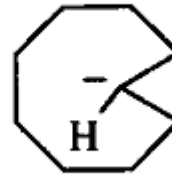

S Z Varsadze's lectures

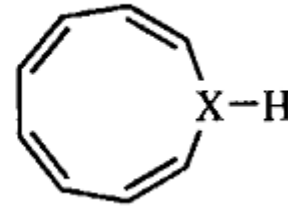

S Z Varsadze's lectures

Для X=N ароматичен

- 10 электронов

S Z Vatsadze's lectures

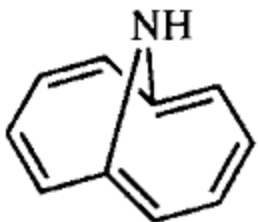

S Z Vatsadze's lectures

S Z Vatsadze's lectures

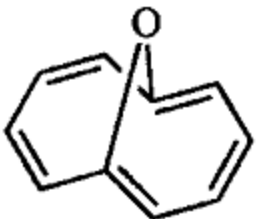

S Z Vatsadze's lectures

S Z Vatsadze's lectures

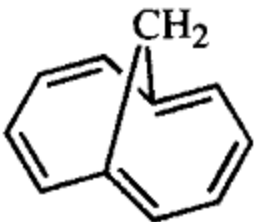

S Z Vatsadze's lectures

S Z Vatsadze's lectures

S Z Vatsadze's lectures

- 10 электронов:  
Фогелевские аннулены

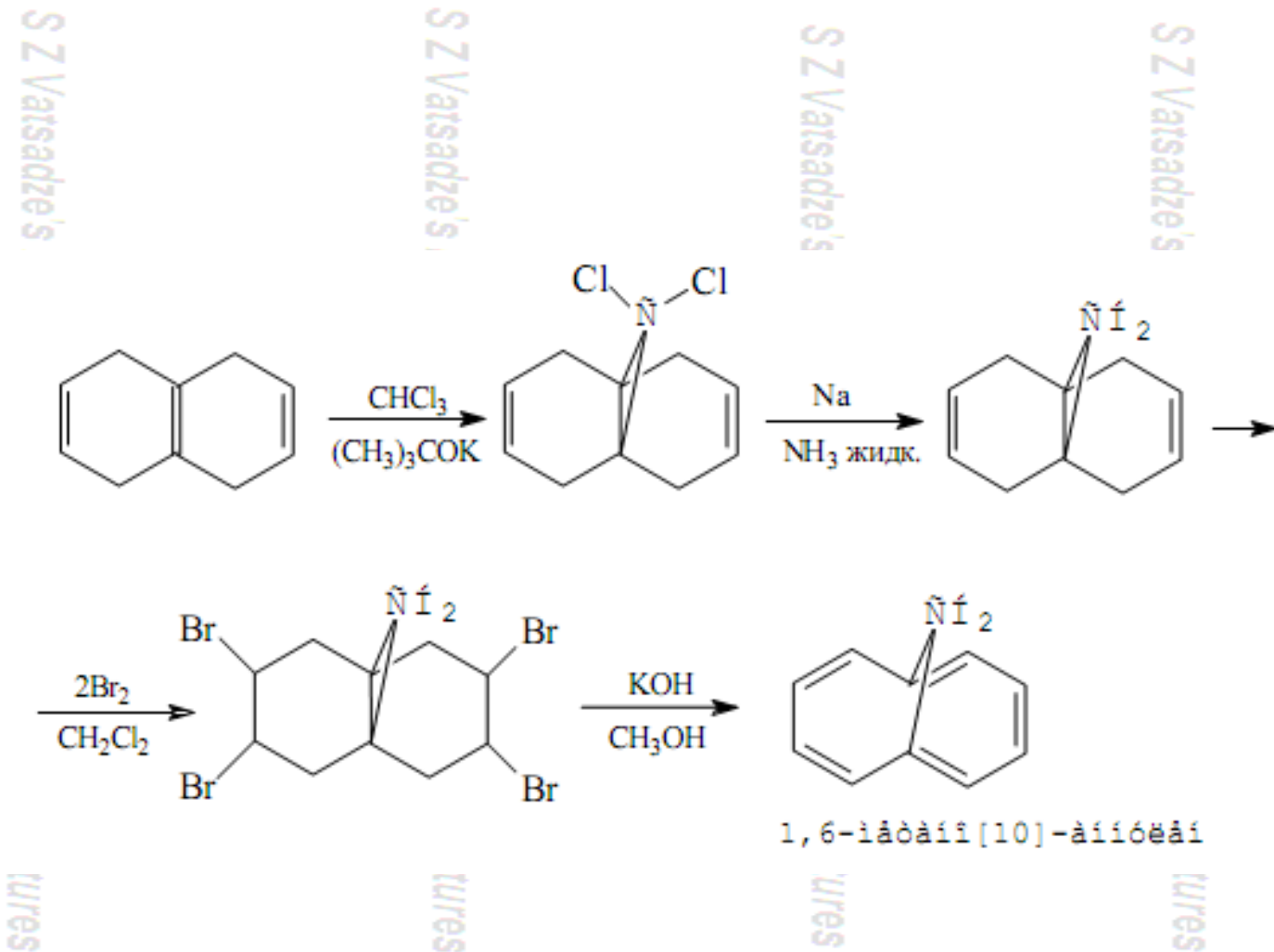

S Z Varsadze's lectures

SZVa

SZV

SZV

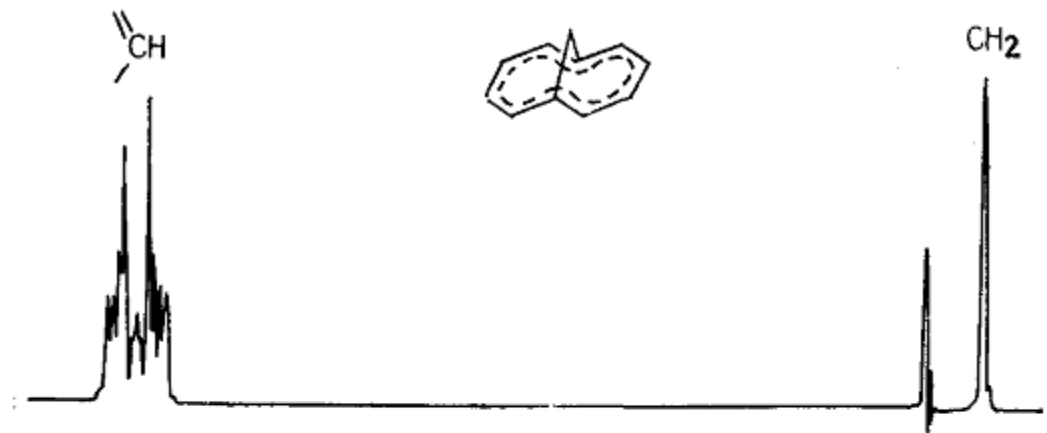

S Z Varsadze's lectures

© 7 Varsadze's lectures

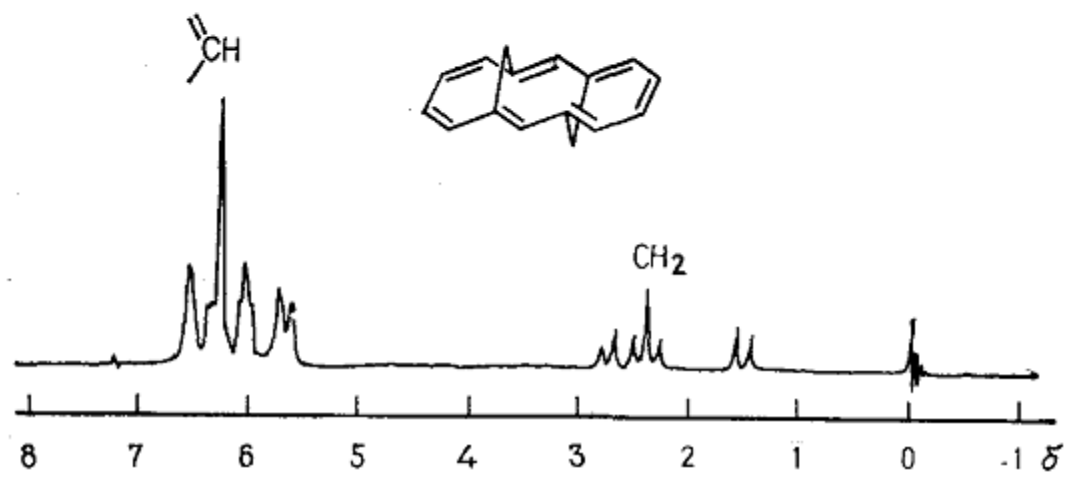

- 10 электронов

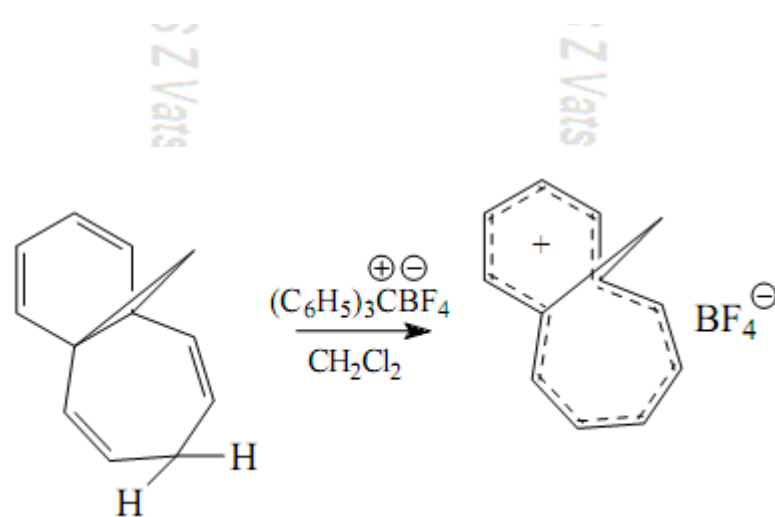
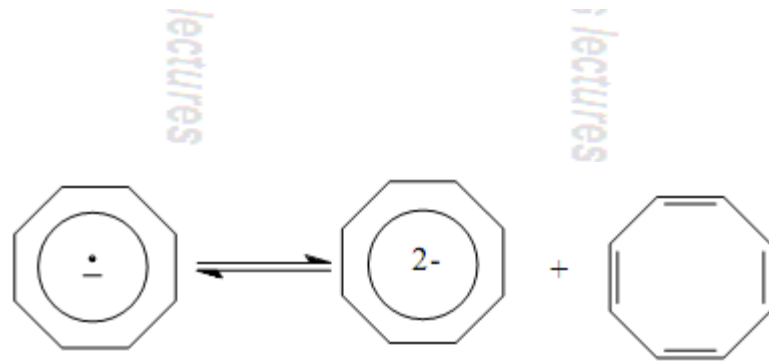
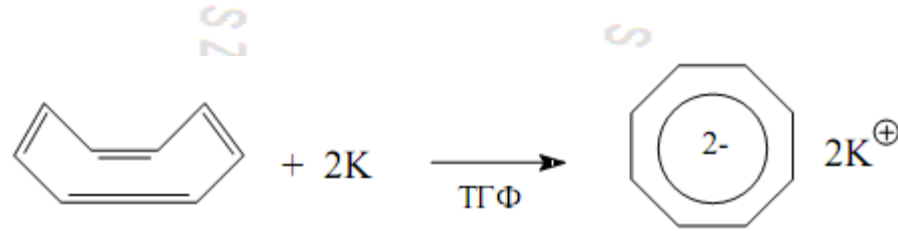

- 12 электронов

S Z Varsadze

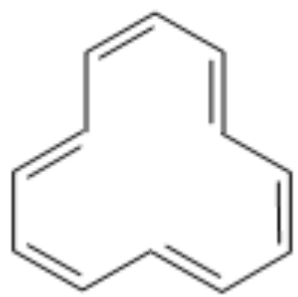

[12]-аннулен

S Z Varsadze

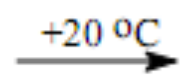
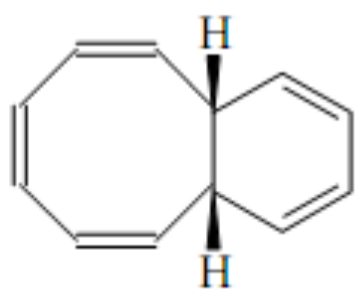
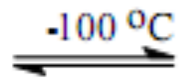

S Z Varsadze

S Z Varsadze

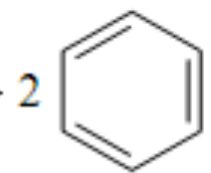
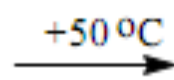
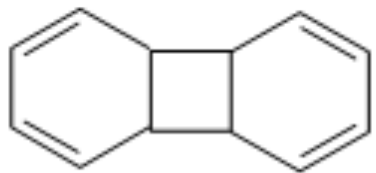
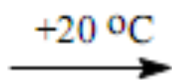

lectures

lectures

lectures

lectures



- 14 электронов ?

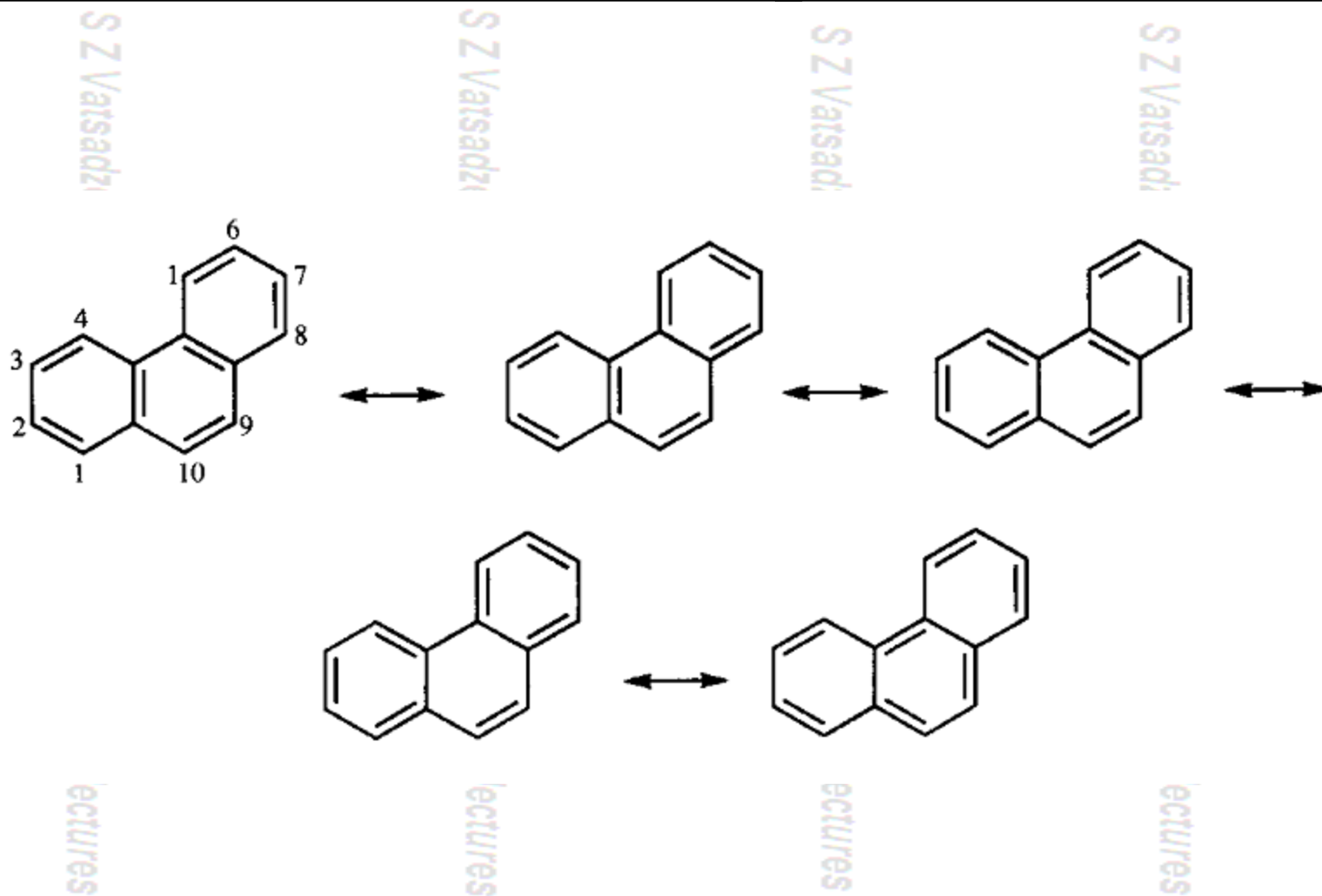

- 14 электронов

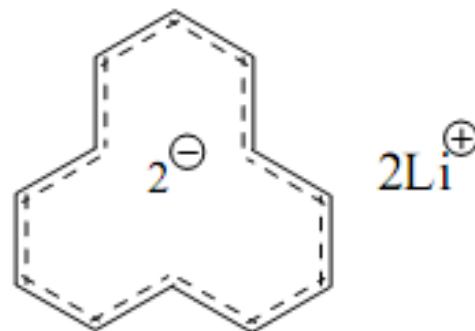
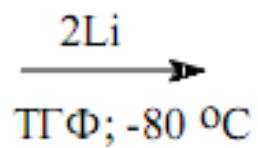
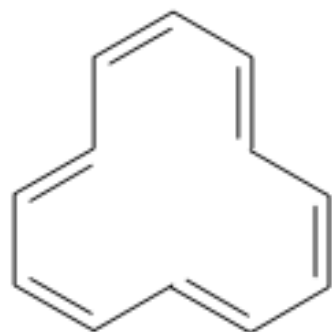

S Z Varsadze's lectures

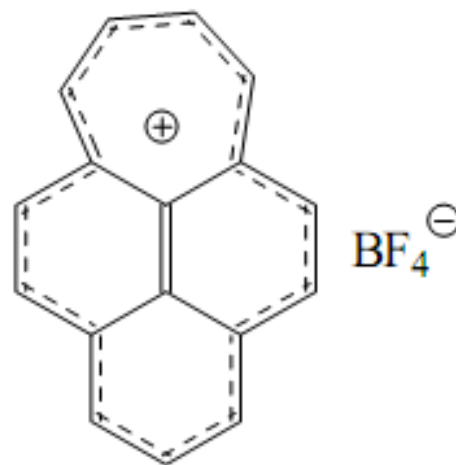
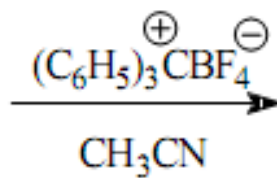
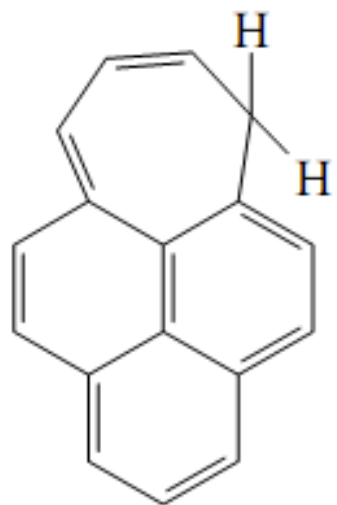

- 14 электронов

## 18. Ароматичность

S Z Vatsadze's lectures

S Z Vatsadze's lectures

S Z Vatsadze's lectures

S Z Vatsadze's lectures

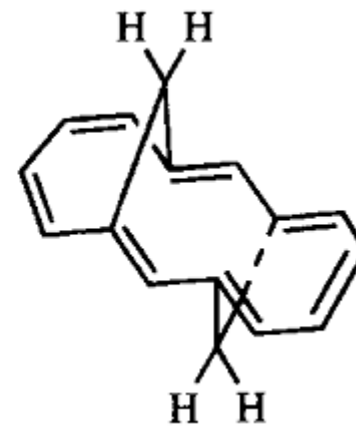
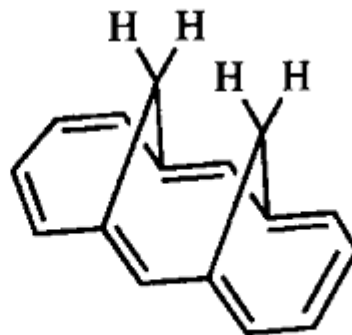
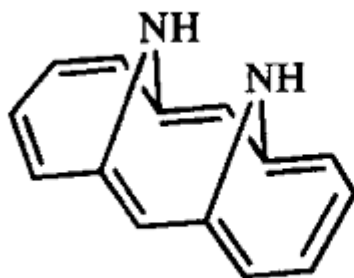
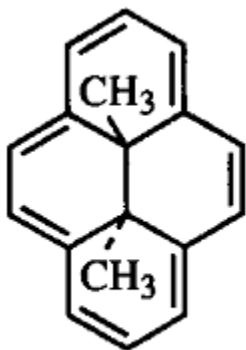
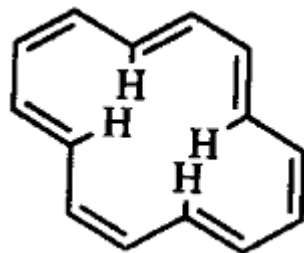

- 14 электронов vs. 16 э.

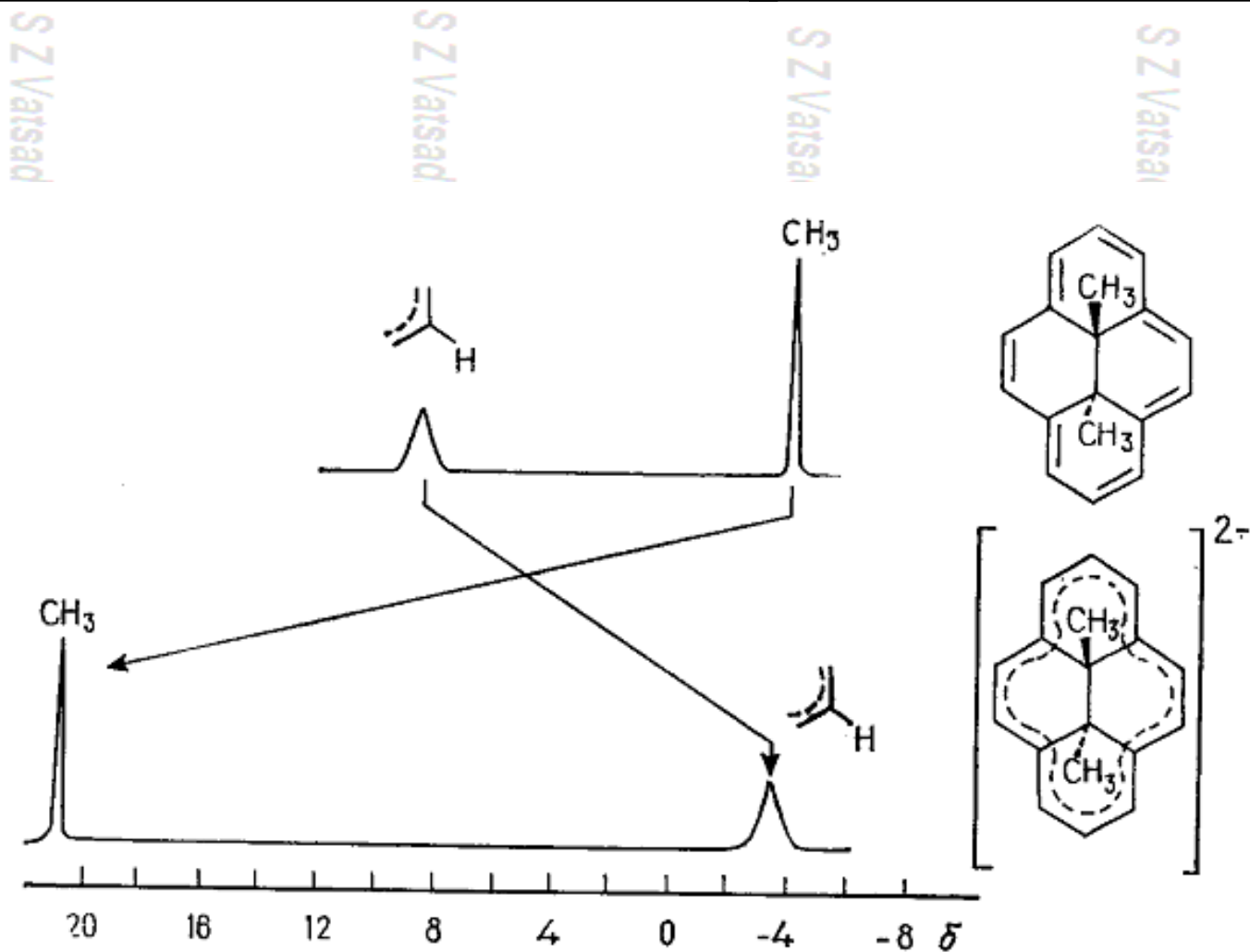

- 16 электронов

S Z Vatsadze's le

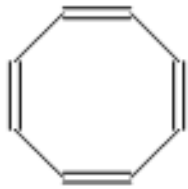

S Z Vatsadze's lectures

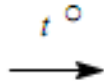

S Z Vatsadze's le

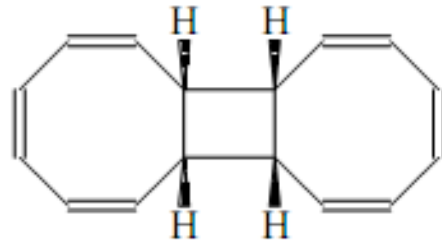

S Z Vatsadze's lectures

S Z Vatsadze's le

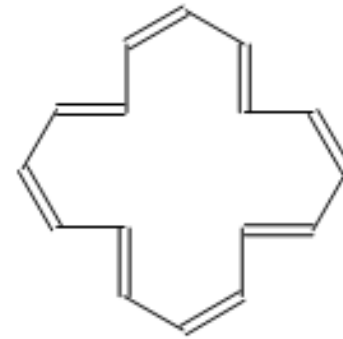
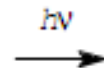

[16]-аннулен

S Z Vatsadze's lectures

неароматичен

S Z Vatsadze's le

S Z Vatsadze's lectures

- 18 электронов

S Z Varsadze's lectures

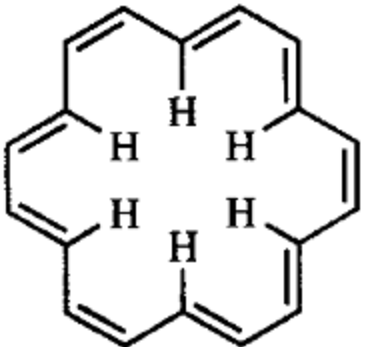

S Z Varsadze's lectures

S Z Varsadze's lectu

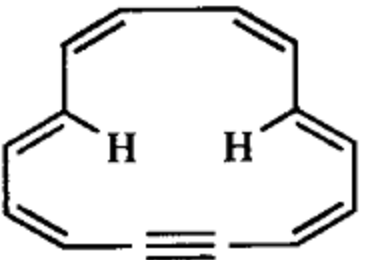

Varsadze's lectures

S Z Varsadze's lectur

S Z Varsadze's lectures

S Z Varsadze's lectures

- 18 электронов

S Z Varsadze's lectures

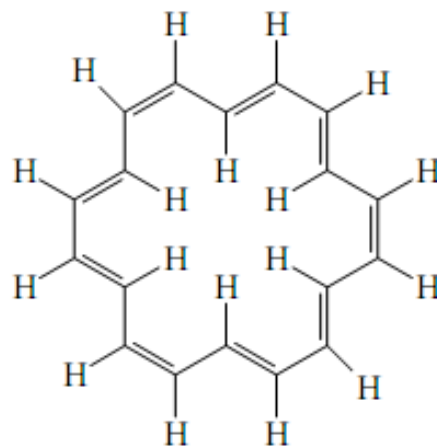
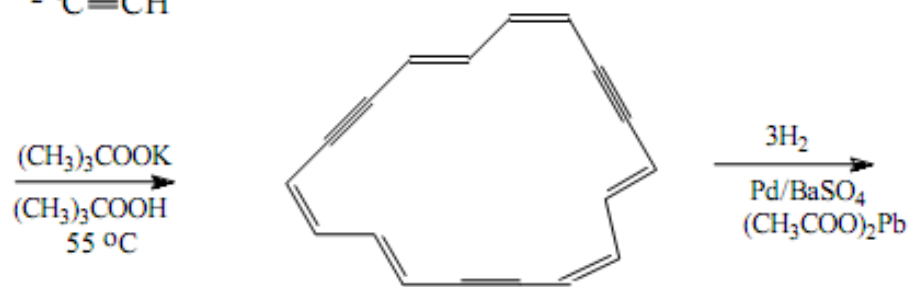
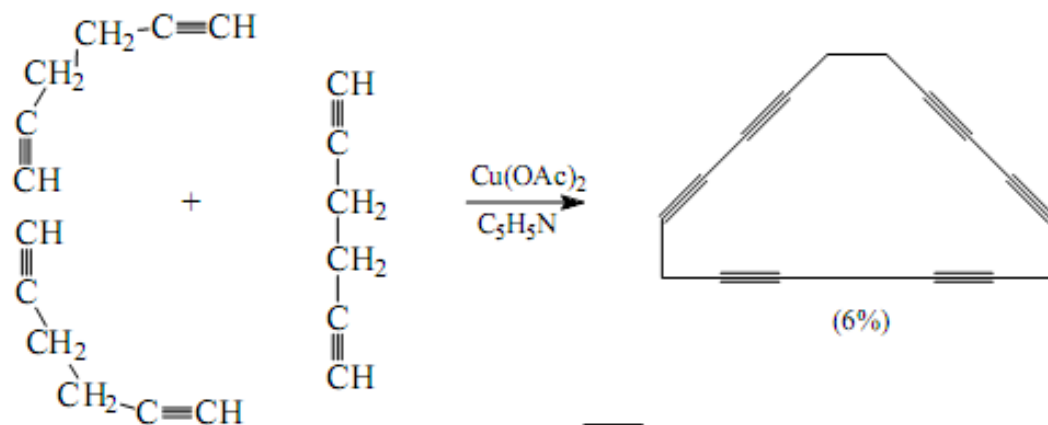

общий выход 1% в расчете на исходный диин

[18]-аннулен

S Z Varsadze's lectures

- Ароматичность

S Z Varsadze's lectures

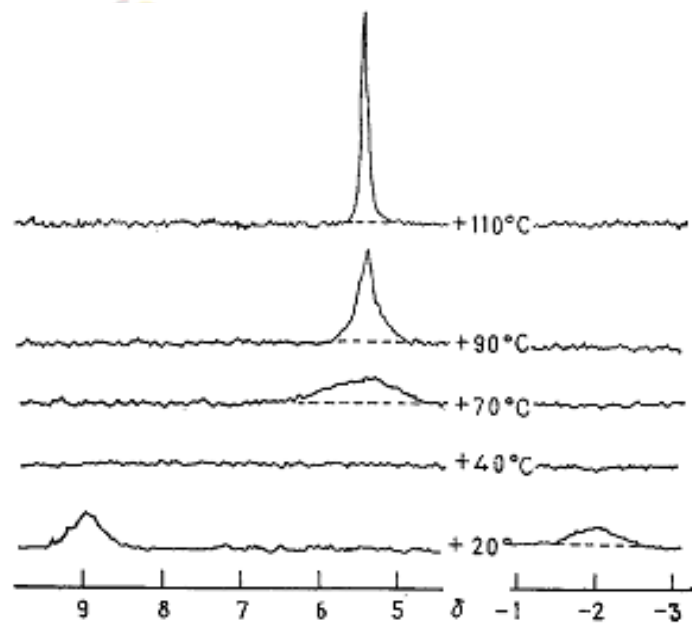

S Z Varsadze's lectures

S Z Varsadze's lectures

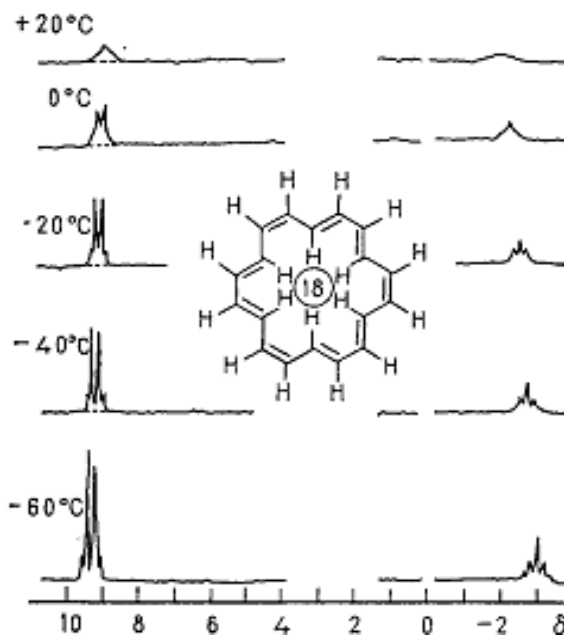

S Z Varsadze's lectures

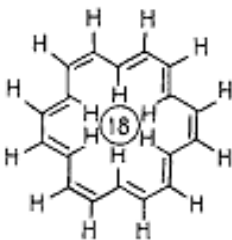



- Кекулен - ? электронов

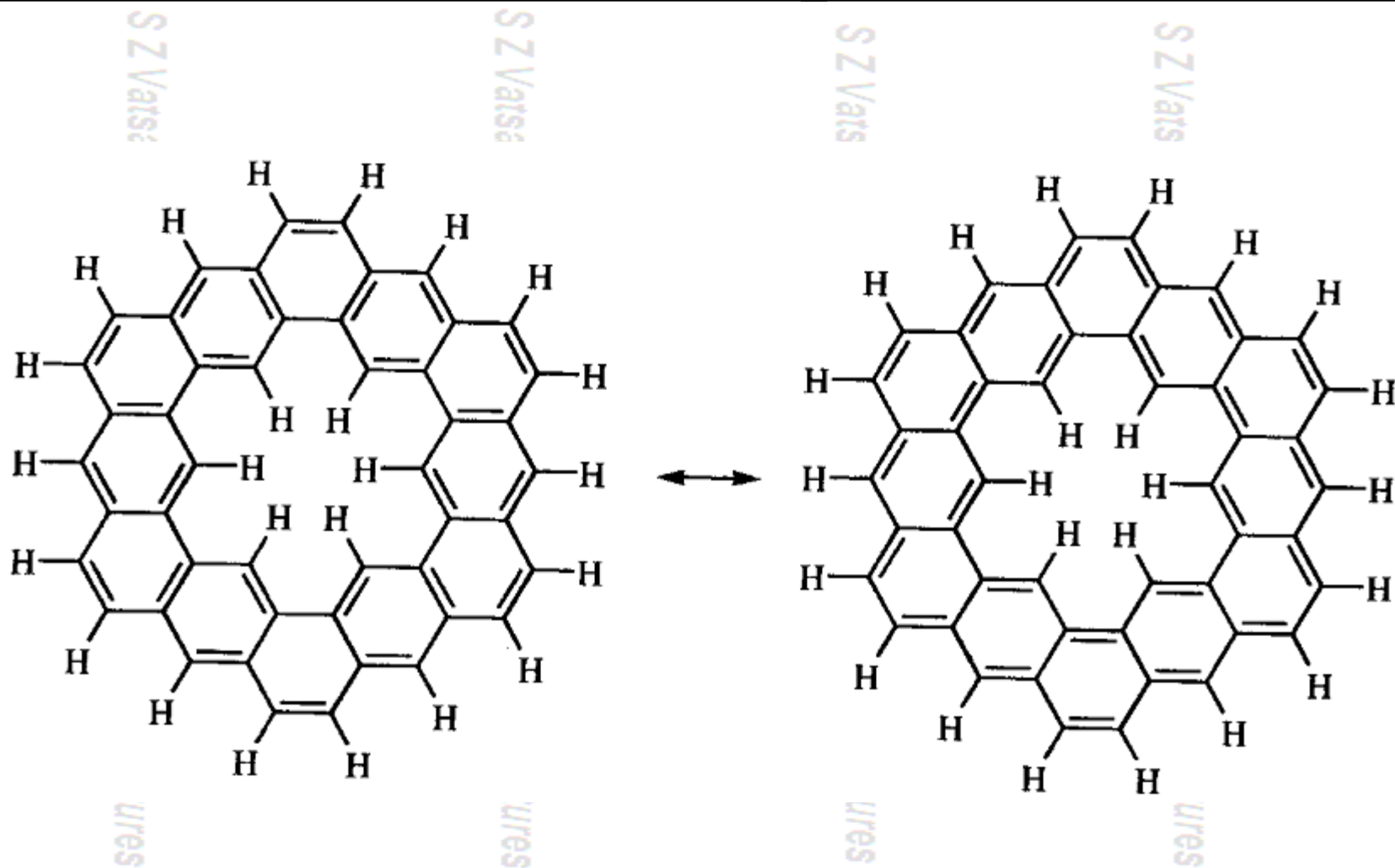

Протонный спектр: 7.94; 8.37; 10.45  
2 : 1 : 1